

SNR 系列功率电感 SNR Series SMD Power Inductors



特征 Features

超薄大电流	Low Profile & High Current
温度最高125°C	High Temperature, Up to 125°C
适合表面贴装	SMT Type



应用 Applications

笔记本电脑	Notebook Computer
LED电视	LED Television
DC/DC转换	DC/DC Converters

产品规格型号表示方法 How to Order

SNR4020 - **2R2** **M** **S**
(1) (2) (3) (4)

- (1) 系列名称 Series Name
- (2) 电感感值 Inductance(μH)
- (3) 精度误差 Tolerance
- (4) 内部代码 Internal Code

外型尺寸 Dimensions

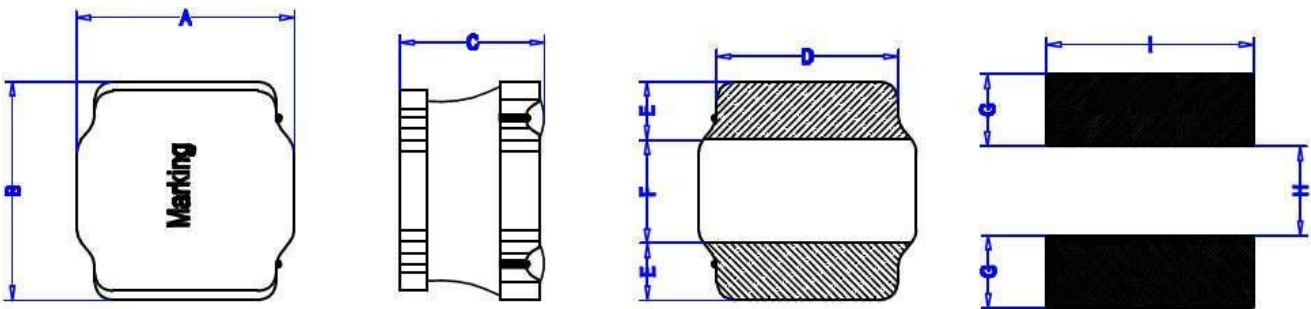

Type Name	A	B	C	D	E	F	G	H	I
SNR4020(mm)	4.0±0.2	4.0±0.2	2.0 Max.	3.3±0.3	0.95±0.2	2.1±0.2	1.1 Ref.	1.9 Ref.	3.7 Ref.

性能参数 Electrical Characteristics

规格型号 Part No.	电感值 Inductance(μ H)	直流电阻 Rdc(m Ω) Max.	饱和电流 Isat(A) Max.	温升电流 Irms(A) Max.
SNR4020-R47NS	0.47 \pm 30%	29.0	7.00	3.30
SNR4020-R68NS	0.68 \pm 30%	36.0	6.40	2.80
SNR4020-1R0NS	1.0 \pm 30%	38.0	4.78	2.15
SNR4020-1R5NS	1.5 \pm 30%	46.0	4.45	1.98
SNR4020-2R2MS	2.2 \pm 20%	52.0	3.40	1.85
SNR4020-3R3MS	3.3 \pm 20%	91.0	3.20	1.40
SNR4020-4R7MS	4.7 \pm 20%	98.0	2.35	1.34
SNR4020-5R6MS	5.6 \pm 20%	117	2.20	1.22
SNR4020-6R8MS	6.8 \pm 20%	163	2.20	1.04
SNR4020-8R2MS	8.2 \pm 20%	163	1.75	1.04
SNR4020-100MS	10.0 \pm 20%	215	1.60	0.90
SNR4020-120MS	12.0 \pm 20%	228	1.50	0.88
SNR4020-150MS	15.0 \pm 20%	299	1.35	0.77
SNR4020-220MS	22.0 \pm 20%	455	1.05	0.62
SNR4020-330MS	33.0 \pm 20%	715	0.85	0.49
SNR4020-470MS	47.0 \pm 20%	923	0.74	0.44
SNR4020-560MS	56.0 \pm 20%	1040	0.66	0.41
SNR4020-680MS	68.0 \pm 20%	1380	0.61	0.36
SNR4020-820MS	82.0 \pm 20%	1520	0.50	0.34
SNR4020-101MS	100.0 \pm 20%	2020	0.48	0.31

备注 Remark:

- 所有测试数据均参考18-25°C环境温度
All test data is referenced to 18-25°C ambient;
- 电感测试条件为用WK3260B或同等设备以100KHz/0.25V测试
Inductance tested at 100KHz/0.25V with WK3260B LCR Meter or equivalent;
- 饱和电流: 加电流时电感量下降小于或等于30%
Isat: DC current at which the inductance drops 30% from its value without saturation;
- 温升电流: 加电流时产品温度上升小于等于40°C
Irms: DC current that causes the temperature rise ($\Delta T = 40^\circ\text{C}$) from ambient temperature;
- 工作温度 (包括自身发热) : -40°C~+ 125°C
Operating temperature range (including coil's self-temperature rise): -40°C~+ 125°C.

包装材料及规格 Packaging Materials and Specifications

卷轴尺寸图 Reel Size

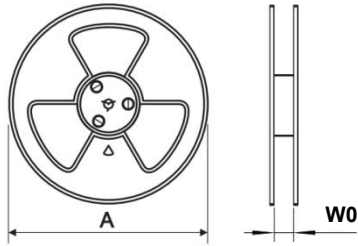

Reel

包装带尺寸图 Tape Size

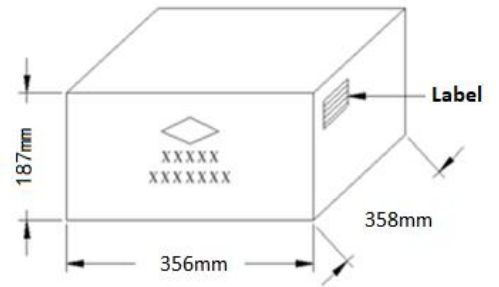
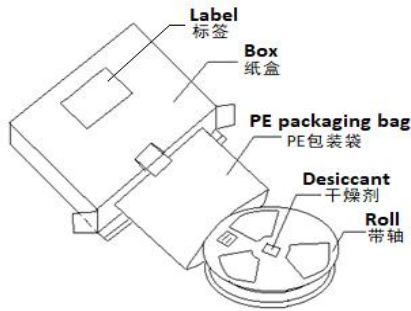
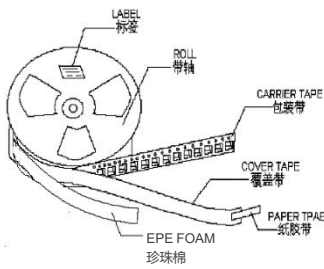
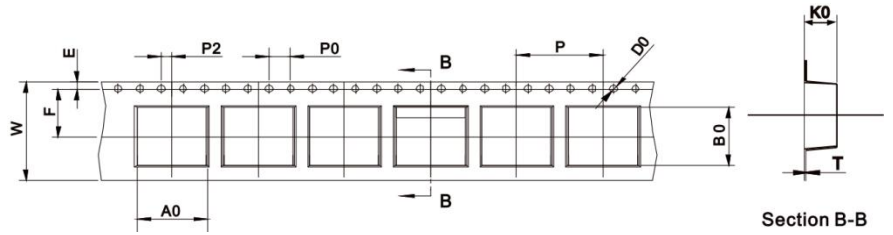

Code	A	W0	P	W	D0	A0	B0	K0	T	pcs/Reel
Specification(mm)	330	12.8	8.0	12.0	1.5	4.35	4.35	2.25	0.30	3000

内外箱标识内容 Inside and Outside Box Identification Content

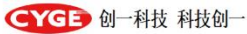

Made in China
<HSF/ROHS>

Customer Name: XXXXXXXX



2

P/O: XXXXXXXXXXXXXXXXXXXX



Customer P/N: XXXXXXXXXX



CYGE P/N: XXXXXXXXXXXXXXXX



LOT NO: XXXXXXXXXX

DATE: XXXXX

QTY: XXXX PCS



匠心致远 追求卓越 感动人心
Following ingenuity, pursuing excellence, touching hearts

推荐回流焊条件 Recommended Reflow Soldering Conditions



Profile Feature	Lead-Free Assembly
Preheat Temperature Min (T_s min)	150°C
Preheat Temperature Max (T_s max)	200°C
Preheat Time t_s from T_s min to T_s max	60-120 seconds
Average Ramp-Up Rate (T_L to T_P)	3°C /second max.
Liquidous Temperature (T_L)	217°C
Time t_L maintained above T_L (t_L)	60-150 seconds
Peak/Classification Temperature (T_P)	255°C
Time within 5°C of actual peak temperature (t_p)	20-30 second
Ramp-down Rate (T_P to T_L)	6 °C/second max.
Time 25 °C to Peak Temperature	8 minutes max.

储存条件/注意的事项 Storage Conditions/Note Things

1、贮存温度、湿度条件 Storage temperature and humidity conditions :

1.1、产品包装与载体: -5°C ~ +40°C, 低于60% RH.

Product packing with Carrier tape: -5°C ~ +40°C and less than 60% RH.

1.2、单独的产品: -20°C ~ +60°C, 低于60% RH.

Product alone: -20°C ~ +60°C and less than 60% RH.

2、产品在6个月内使用(注意:产品一经拆开包装,须尽快使用).

Products should be used within 6 months.

(Note that the product should be used as soon as possible once it is folded) .

3、包装材料应保存在空气中不存在氯或硫的地方.

The packaging material should be kept where no chlorine or sulfur exists in the air.

4、不要用手指触摸电极(焊接端子),因为这可能导致焊接能力的下降.

Do not touch the electrodes (soldering terminals) with fingers as this may lead to deterioration of solderability.

5、个别零件强烈建议使用镊子或真空取料机散装搬运应减少磨损和机械冲击.

The use of tweezers or vacuum pick-ups is strongly recommended for individual components.

Bulk handling should ensure that abrasion and mechanical shock are minimized.